

LM2941/LM2941C

1A Low Dropout Adjustable Regulator

General Description

The LM2941 positive voltage regulator features the ability to source 1A of output current with a typical dropout voltage of 0.5V and a maximum of 1V over the entire temperature range. Furthermore, a quiescent current reduction circuit has been included which reduces the ground pin current when the differential between the input voltage and the output voltage exceeds approximately 3V. The quiescent current with 1A of output current and an input-output differential of 5V is therefore only 30mA. Higher quiescent currents only exist when the regulator is in the dropout mode ($V_{IN} - V_{OUT} \leq 3V$).

Designed also for vehicular applications, the LM2941 and all regulated circuitry are protected from reverse battery installations or two-battery jumps. During line transients, such as load dump when the input voltage can momentarily exceed the specified maximum operating voltage, the regulator will automatically shut down to protect both the internal circuits

and the load. Familiar regulator features such as short circuit and thermal overload protection are also provided.

Features

- LLP space saving package
- Output voltage adjustable from 5V to 20V
- Dropout voltage typically 0.5V @ $I_O = 1A$
- Output current in excess of 1A
- Trimmed reference voltage
- Reverse battery protection
- Internal short circuit current limit
- Mirror image insertion protection
- P+ Product Enhancement tested
- TTL, CMOS compatible ON/OFF switch

Connection Diagram and Ordering Information

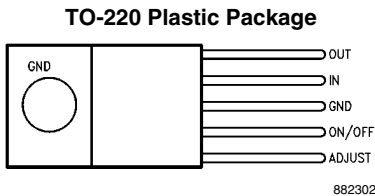

Top View

Order Number LM2941T or LM2941CT
See NS Package Number TO5A

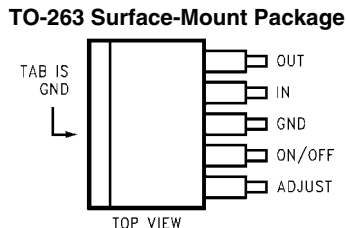

TOP VIEW

Order Number LM2941S, LM2941SX or
LM2941CS, LM2941CSX
See NS Package Number TS5B

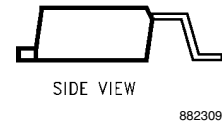

SIDE VIEW

882309

16-Lead Ceramic Dual-in-Line Package

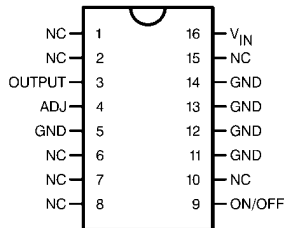

Top View

Order Number LM2941J/883
LM2941J-QMLV, 5962-9166701QEA
See NS Package Number J16A

16-Lead Ceramic Surface Mount Package

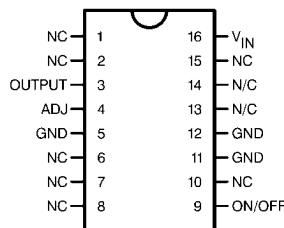

Top View

Order Number LM2941WG/883
LM2941WG-QMLV, 5962-9166701QYA
See NS Package Number WG16A

8-Lead LLP Surface Mount Package

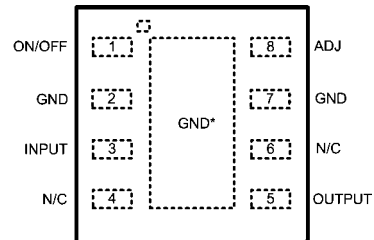

* TIE TO GND OR LEAVE FLOATING

Ordering Number LM2941LD,
LM2941LDX
See NS Package Number LDC08A

Note: Pin 2 & 7 are fused to center DAP

Absolute Maximum Ratings (Note 1)

If Military/Aerospace specified devices are required, please contact the National Semiconductor Sales Office/ Distributors for availability and specifications.

Input Voltage (Survival Voltage, $\leq 100\text{ms}$)	
LM2941T, LM2941S, LM2941LD	60V
LM2941CT, LM2941CS	45V
Internal Power Dissipation (Note 4)	Internally Limited
Maximum Junction Temperature	150°C
Storage Temperature Range	$-65^\circ\text{C} \leq T_J \leq +150^\circ\text{C}$
Lead Temperature (Soldering, 10 seconds)	
TO-220 (T) Package	260°C

TO-263 (S) Package
ESD Rating (Note 2)

260°C
 $\pm 2\text{ kV}$

Operating Ratings

Maximum Input Voltage	26V
Temperature Range	
LM2941T	$-40^\circ\text{C} \leq T_J \leq 125^\circ\text{C}$
LM2941CT	$0^\circ\text{C} \leq T_J \leq 125^\circ\text{C}$
LM2941S	$-40^\circ\text{C} \leq T_J \leq 125^\circ\text{C}$
LM2941CS	$0^\circ\text{C} \leq T_J \leq 125^\circ\text{C}$
LM2941J	$-55^\circ\text{C} \leq T_J \leq 125^\circ\text{C}$
LM2941WG	$-55^\circ\text{C} \leq T_J \leq 125^\circ\text{C}$
LM2941LD	$-40^\circ\text{C} \leq T_J \leq 125^\circ\text{C}$

Electrical Characteristics—LM2941T, LM2941S, LM2941J, LM2941WG, LM2941LD

$5\text{V} \leq V_O \leq 20\text{V}$, $V_{IN} = V_O + 5\text{V}$, $C_O = 22\mu\text{F}$, unless otherwise specified. Specifications in standard typeface apply for $T_J = 25^\circ\text{C}$, while those in **boldface type** apply over the full **Operating Temperature Range**.

Parameter	Conditions	Typ	LM2941J LM2941WG Limit (Notes 3, 5)	LM2941T LM2941S LM2941LD Limit (Note 6)	Units (Limits)
Reference Voltage	$5\text{mA} \leq I_O \leq 1\text{A}$ (Note 7)	1.275	1.237/ 1.211 1.313/ 1.339	1.237/ 1.211 1.313/ 1.339	V(min) V(max)
Line Regulation	$V_O + 2\text{V} \leq V_{IN} \leq 26\text{V}$, $I_O = 5\text{mA}$	4	10/ 10	10/ 10	mV/V(max)
Load Regulation	$50\text{mA} \leq I_O \leq 1\text{A}$	7	10/ 10	10/ 10	mV/V(max)
Output Impedance	100 mADC and 20 mArms $f_O = 120\text{Hz}$	7			m Ω /V
Quiescent Current	$V_O + 2\text{V} \leq V_{IN} < 26\text{V}$, $I_O = 5\text{mA}$	10	15/ 20	15/ 20	mA(max)
	$V_{IN} = V_O + 5\text{V}$, $I_O = 1\text{A}$	30	45/ 60	45/ 60	mA(max)
RMS Output Noise, % of V_{OUT}	10Hz–100kHz $I_O = 5\text{mA}$	0.003			%
Ripple Rejection	$f_O = 120\text{Hz}$, 1 Vrms, $I_L = 100\text{mA}$	0.005	0.02/ 0.04	0.02/ 0.04	%/V(max)
Long Term Stability		0.4			%/1000 Hr
Dropout Voltage	$I_O = 1\text{A}$	0.5	0.8/ 1.0	0.8/ 1.0	V(max)
	$I_O = 100\text{mA}$	110	200/ 200	200/ 200	mV(max)
Short Circuit Current	V_{IN} Max = 26V (Note 8)	1.9	1.6/ 1.3	1.6	A(min)
Maximum Line Transient	V_O Max 1V Above Nominal V_O $R_O = 100$, $T \leq 100\text{ms}$	75	60/ 60	60/ 60	V(min)
Maximum Operational Input Voltage		31	26/ 26	26/ 26	V_{DC}
Reverse Polarity DC Input Voltage	$R_O = 100$, $V_O \geq -0.6\text{V}$	-30	-15/ -15	-15/ -15	V(min)
Reverse Polarity Transient Input Voltage	$T \leq 100\text{ms}$, $R_O = 100\Omega$	-75	-50/ -50	-50/ -50	V(min)
ON/OFF Threshold Voltage ON	$I_O \leq 1\text{A}$	1.30	0.80/ 0.80	0.80/ 0.80	V(max)
ON/OFF Threshold Voltage OFF	$I_O \leq 1\text{A}$	1.30	2.00/ 2.00	2.00/ 2.00	V(min)
ON/OFF Threshold Current	$V_{ON/OFF} = 2.0\text{V}$, $I_O \leq 1\text{A}$	50	100/ 300	100/ 300	μA (max)

Electrical Characteristics—LM2941CT, LM2941CS

$5V \leq V_O \leq 20V$, $V_{IN} = V_O + 5V$, $C_O = 22\mu F$, unless otherwise specified. Specifications in standard typeface apply for $T_J = 25^\circ C$, while those in **boldface type** apply over the full **Operating Temperature Range**.

Parameter	Conditions	Typ	Limit (Note 6)	Units (Limits)
Reference Voltage	$5mA \leq I_O \leq 1A$ (Note 7)	1.275	1.237/ 1.211 1.313/ 1.339	V(min) V(max)
Line Regulation	$V_O + 2V \leq V_{IN} \leq 26V$, $I_O = 5mA$	4	10	mV/V(max)
Load Regulation	$50mA \leq I_O \leq 1A$	7	10	mV/V(max)
Output Impedance	100 mADC and 20 mArms $f_O = 120Hz$	7		mΩ/V
Quiescent Current	$V_O + 2V \leq V_{IN} < 26V$, $I_O = 5mA$	10	15	mA(max)
	$V_{IN} = V_O + 5V$, $I_O = 1A$	30	45/60	mA(max)
RMS Output Noise, % of V_{OUT}	10Hz–100kHz $I_O = 5mA$	0.003		%
Ripple Rejection	$f_O = 120Hz$, 1 Vrms, $I_L = 100mA$	0.005	0.02	%/V(max)
Long Term Stability		0.4		%/1000 Hr
Dropout Voltage	$I_O = 1A$	0.5	0.8/1.0	V(max)
	$I_O = 100mA$	110	200/200	mV(max)
Short Circuit Current	$V_{IN} \text{ Max} = 26V$ (Note 8)	1.9	1.6	A(min)
Maximum Line Transient	$V_O \text{ Max } 1V \text{ Above Nominal } V_O$ $R_O = 100\Omega$, $T \leq 100ms$	55	45	V(min)
Maximum Operational Input Voltage		31	26	V_{DC}
Reverse Polarity DC Input Voltage	$R_O = 100\Omega$, $V_O \geq -0.6V$	-30	-15	V(min)
Reverse Polarity Transient Input Voltage	$T \leq 100ms$, $R_O = 100\Omega$	-55	-45	V(min)
ON/OFF Threshold Voltage ON	$I_O \leq 1A$	1.30	0.80	V(max)
ON/OFF Threshold Voltage OFF	$I_O \leq 1A$	1.30	2.00	V(min)
ON/OFF Threshold Current	$V_{ON/OFF} = 2.0V$, $I_O \leq 1A$	50	100	μA(max)

Thermal Performance

Thermal Resistance Junction-to-Case	5-Lead TO-220	3		$^\circ C/W$
	5-Lead TO-263	3		$^\circ C/W$
Thermal Resistance Junction-to-Ambient	5-Lead TO-220	53		$^\circ C/W$
	5-Lead TO-263	73		$^\circ C/W$
	8-Lead LLP (Note 4)	35		$^\circ C/W$

Note 1: Absolute Maximum Ratings indicate limits beyond which damage to the device may occur. Operating ratings indicate conditions for which the device is intended to be functional, but device parameter specifications may not be guaranteed under these conditions. For guaranteed specifications and test conditions, see the Electrical Characteristics.

Note 2: The Human Body Model (HBM) is a 100 pF capacitor discharged through a 1.5kΩ resistor into each pin. Test method is per JESD22–A114.

Note 3: A military RETS specification available upon request. For more information about military-aerospace products, see the Mil-Aero web page at <http://www.national.com/appinfo/milaero/index.html>.

Note 4: The maximum power dissipation is a function of $T_J(\text{max})$, θ_{JA} , and T_A . The maximum allowable power dissipation at any ambient temperature is $P_D = (T_J(\text{max}) - T_A)/\theta_{JA}$. If this dissipation is exceeded, the die temperature will rise above $150^\circ C$ and the LM2941 will go into thermal shutdown. If the TO-263 package is used, the thermal resistance can be reduced by increasing the P.C. board copper area thermally connected to the package: Using 0.5 square inches of copper area, θ_{JA} is $50^\circ C/W$; with 1 square inch of copper area, θ_{JA} is $37^\circ C/W$; and with 1.6 or more square inches of copper area, θ_{JA} is $32^\circ C/W$. Thermal performance for the LLP package was obtained using a JESD51-7 board with six vias, using no airflow and an ambient temperature of $22^\circ C$. The value θ_{JA} for the LLP package is specifically dependent on PCB trace area, trace material, and the number of layers and thermal vias. For improved thermal resistance and power dissipation for the LLP package, refer to Application Note AN-1187. It is recommended that 6 vias be placed under the center pad to improve thermal performance.

Note 5: All limits guaranteed at room temperature (standard typeface) and at temperature extremes (boldface type). All limits are used to calculate Outgoing Quality Level, and are 100% production tested.

Note 6: All limits guaranteed at room temperature (standard typeface) and at temperature extremes (boldface type). All room temperature limits are 100% production tested. All limits at temperature extremes are guaranteed via correlation using standard Statistical Quality Control (SQC) methods.

Note 7: The output voltage range is 5V to 20V and is determined by the two external resistors, R1 and R2. See Typical Application Circuit.

Note 8: Output current capability will decrease with increasing temperature, but will not go below 1A at the maximum specified temperatures.

Typical Performance Characteristics

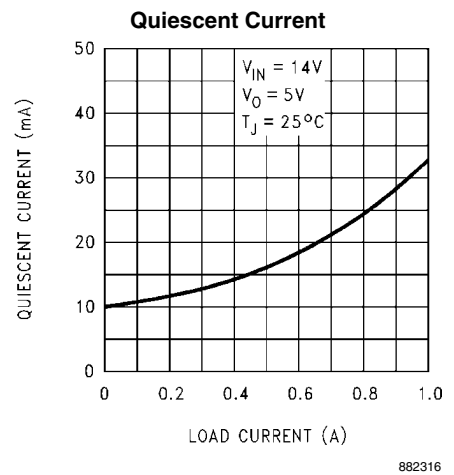
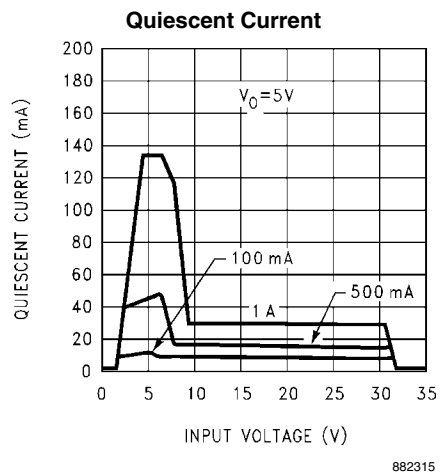
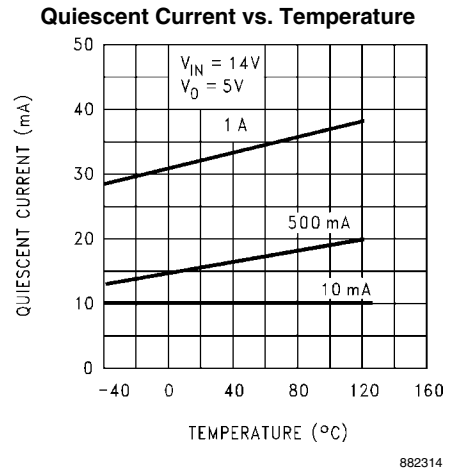
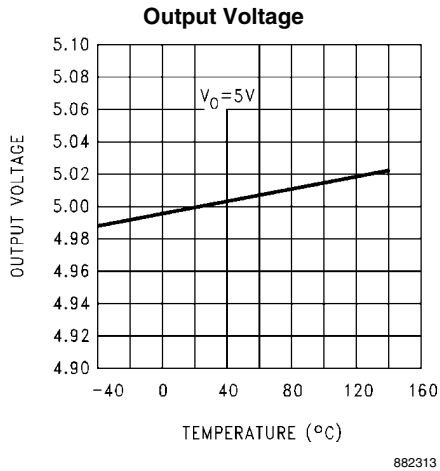
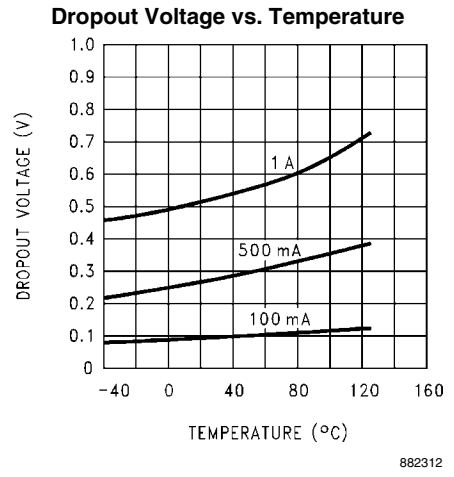
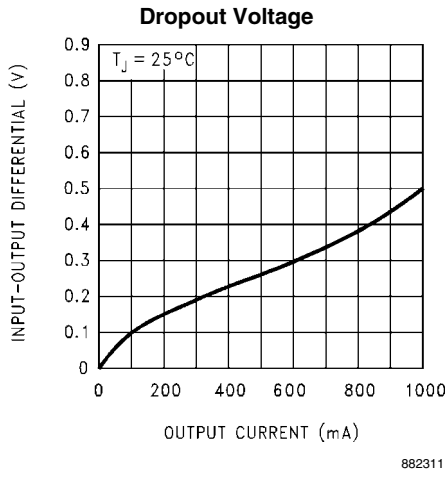

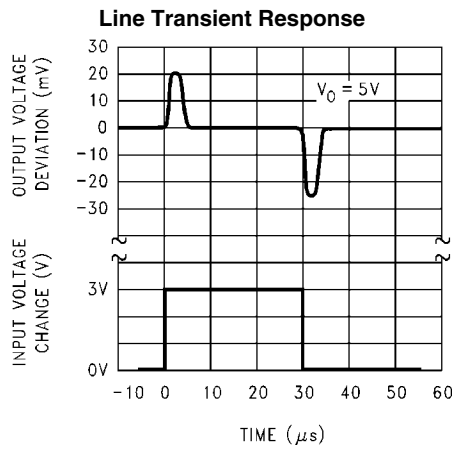

882317

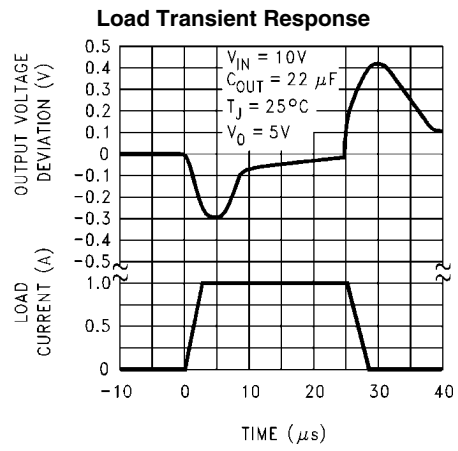

882318

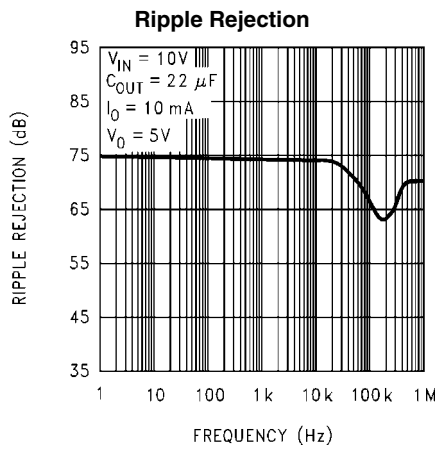

882319

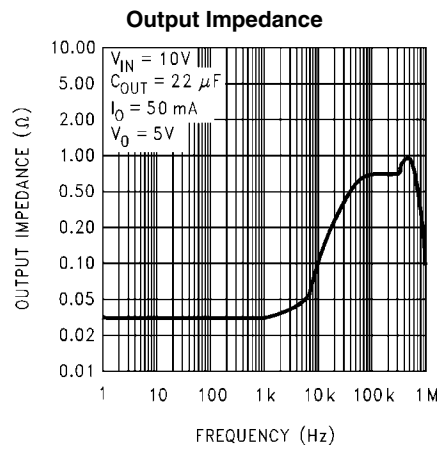

882320

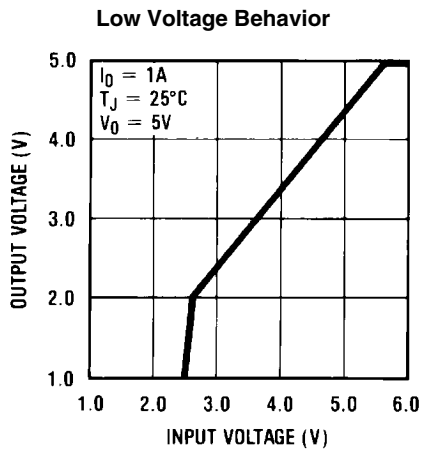

882321

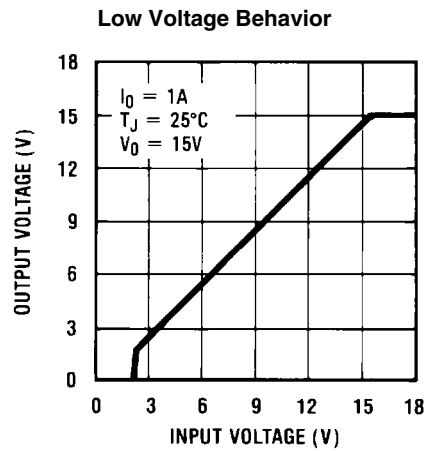

882322

Output Capacitor ESR

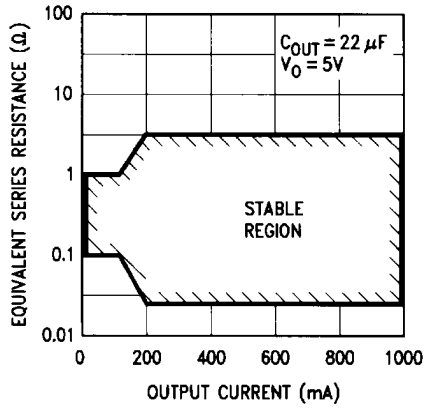

882323

Output at Voltage Extremes

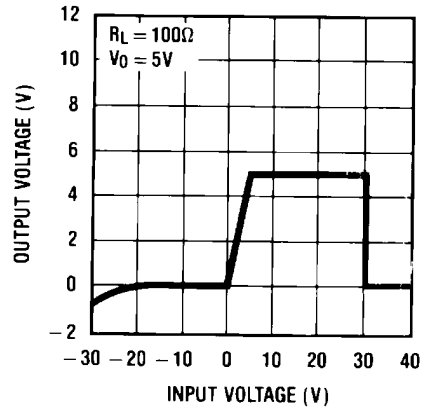

882324

Output at Voltage Extremes

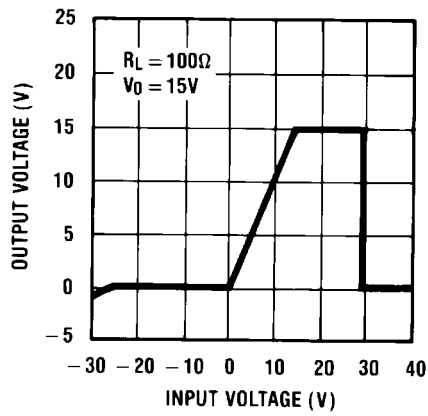

882325

Peak Output Current

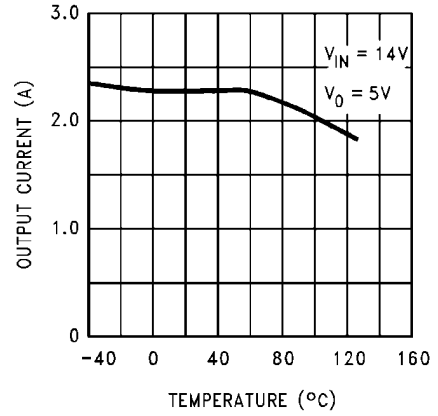

882326

Maximum Power Dissipation (TO-220)

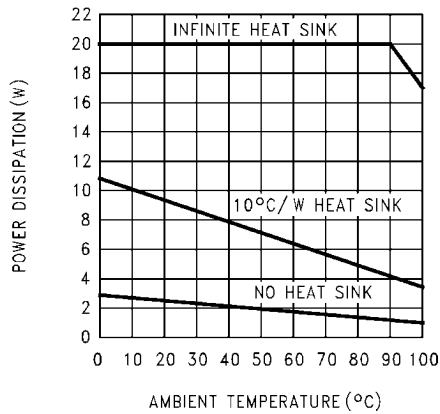

882327

Maximum Power Dissipation (TO-3)

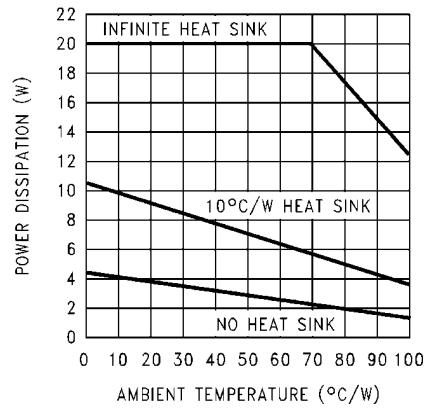

882328

Maximum Power Dissipation (TO-263) (Note 4)

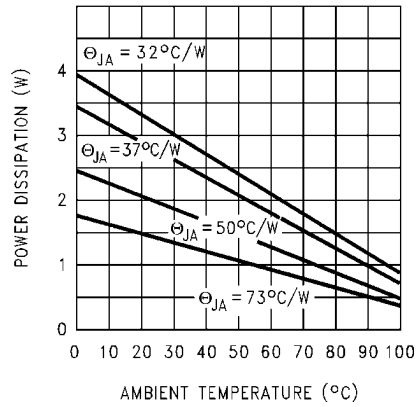

882329

Definition of Terms

Dropout Voltage: The input-voltage differential at which the circuit ceases to regulate against further reduction in input voltage. Measured when the output voltage has dropped 100mV from the nominal value obtained at ($V_{OUT} + 5V$) input, dropout voltage is dependent upon load current and junction temperature.

Input Voltage: The DC voltage applied to the input terminals with respect to ground.

Input-Output Differential: The voltage difference between the unregulated input voltage and the regulated output voltage for which the regulator will operate.

Line Regulation: The change in output voltage for a change in the input voltage. The measurement is made under conditions of low dissipation or by using pulse techniques such that the average chip temperature is not significantly affected.

Load Regulation: The change in output voltage for a change in load current at constant chip temperature.

Long Term Stability: Output voltage stability under accelerated life-test conditions after 1000 hours with maximum rated voltage and junction temperature.

Output Noise Voltage: The rms AC voltage at the output, with constant load and no input ripple, measured over a specified frequency range.

Quiescent Current: That part of the positive input current that does not contribute to the positive load current. The regulator ground lead current.

Ripple Rejection: The ratio of the peak-to-peak input ripple voltage to the peak-to-peak output ripple voltage.

Temperature Stability of V_O : The percentage change in output voltage for a thermal variation from room temperature to either temperature extreme.

Typical Applications

5V to 20V Adjustable Regulator

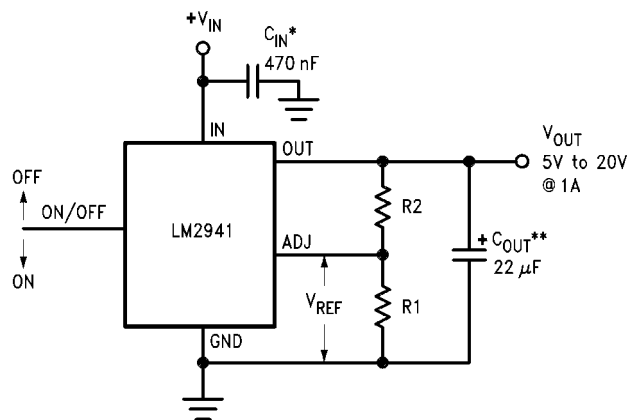

882303

$$V_{OUT} = \text{Reference voltage} \times \frac{R1 + R2}{R1} \text{ where } V_{REF} = 1.275 \text{ typical}$$

$$\text{Solving for R2: } R2 = R1 \left(\frac{V_O}{V_{REF}} - 1 \right)$$

Note: Using 1k for R1 will ensure that the input bias current error of the adjust pin will be negligible. Do not bypass R1 or R2. This will lead to instabilities.

* Required if regulator is located far from power supply filter.

** C_{OUT} must be at least $22\mu F$ to maintain stability. May be increased without bound to maintain regulation during transients. Locate as close as possible to the regulator. This capacitor must be rated over the same operating temperature range as the regulator and the ESR is critical; see curve.

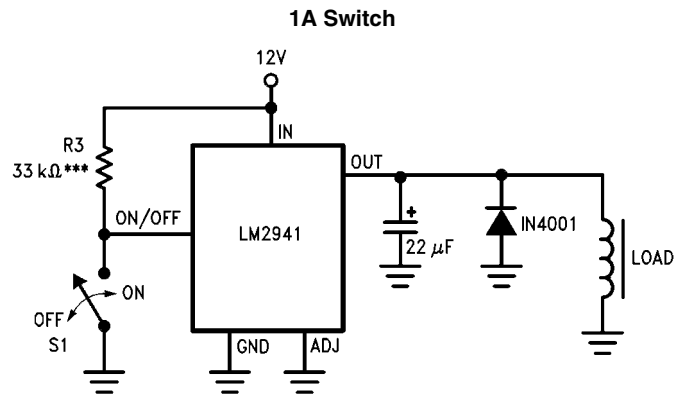

882306

*** To assure shutdown, select Resistor R3 to guarantee at least $300\mu A$ of pull-up current when S1 is open. (Assume 2V at the ON/OFF pin.)

Equivalent Schematic Diagram

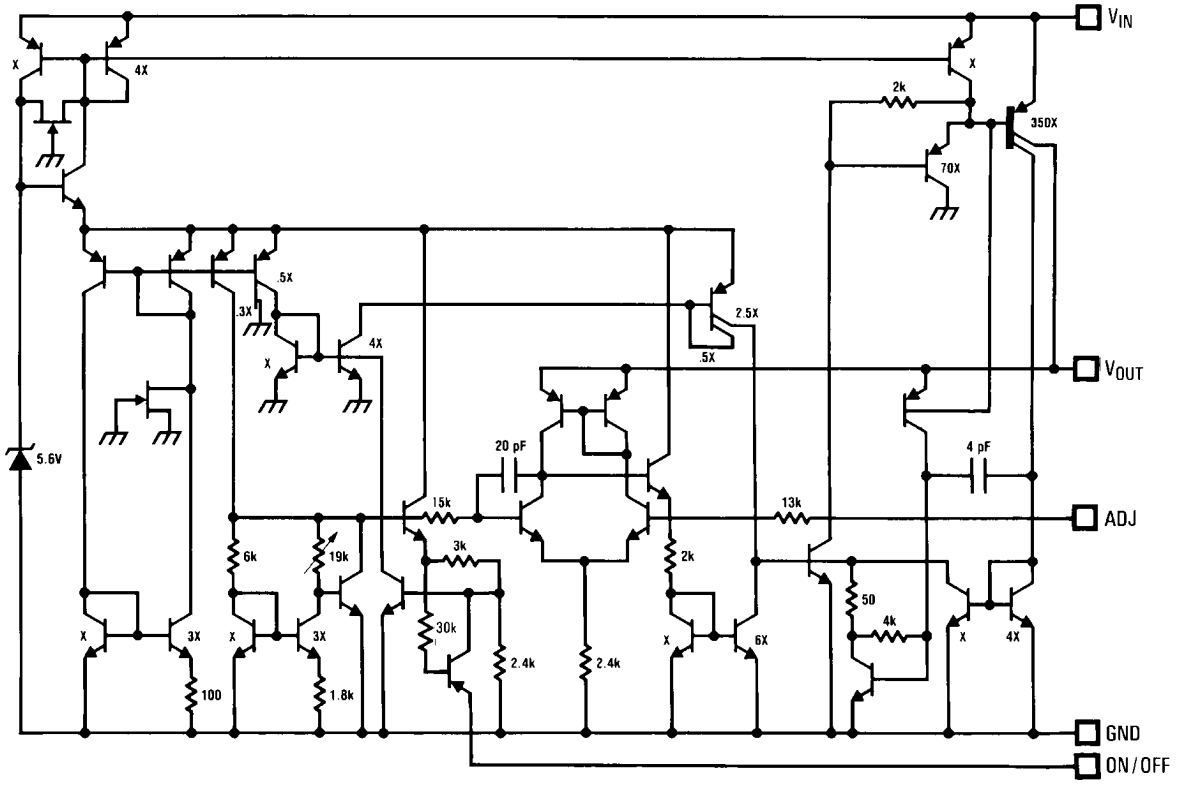

882301

LM2941/LM2941C

Physical Dimensions inches (millimeters) unless otherwise noted

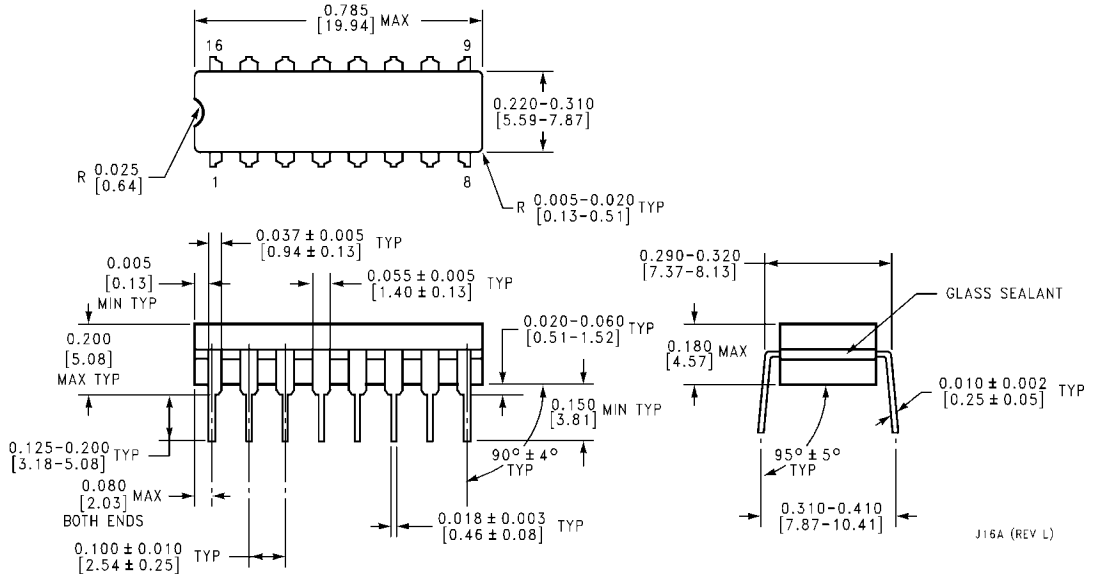

Order Number LM2941J/883
 LM2941J-QMLV, 5962-9166701QEA
 NS Package Number J16A

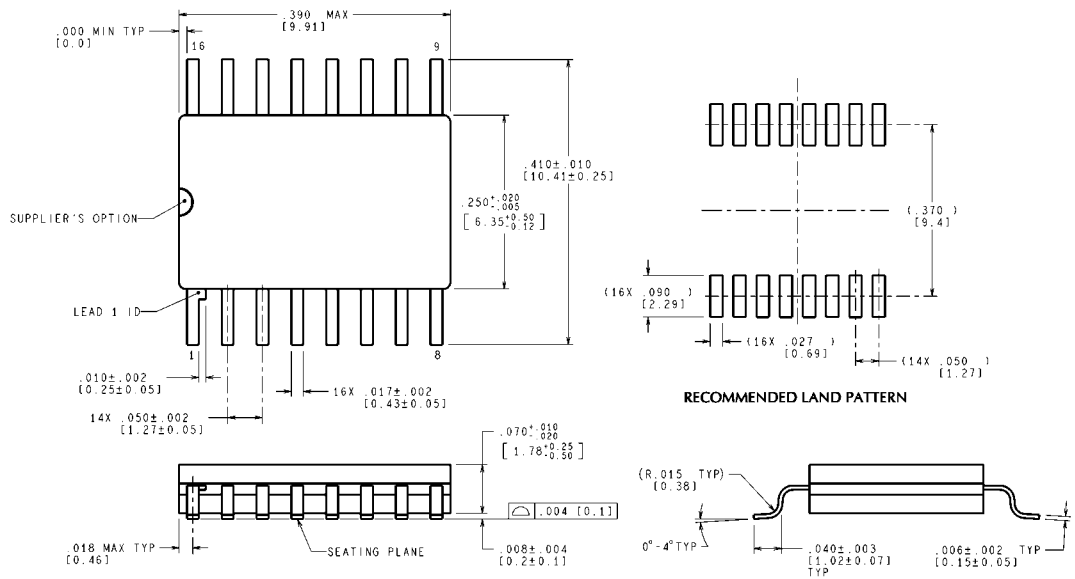

MIL-PRF-38535
 CONFIGURATION CONTROL

CONTROLLING DIMENSION IS INCH
 VALUES IN [] ARE MILLIMETERS
 DIMENSIONS IN () FOR REFERENCE ONLY

WG16A (Rev E)

Order Number LM2941WG/883
 LM2941WG-QMLV, 5962-9166701QYA
 NS Package Number WG16A

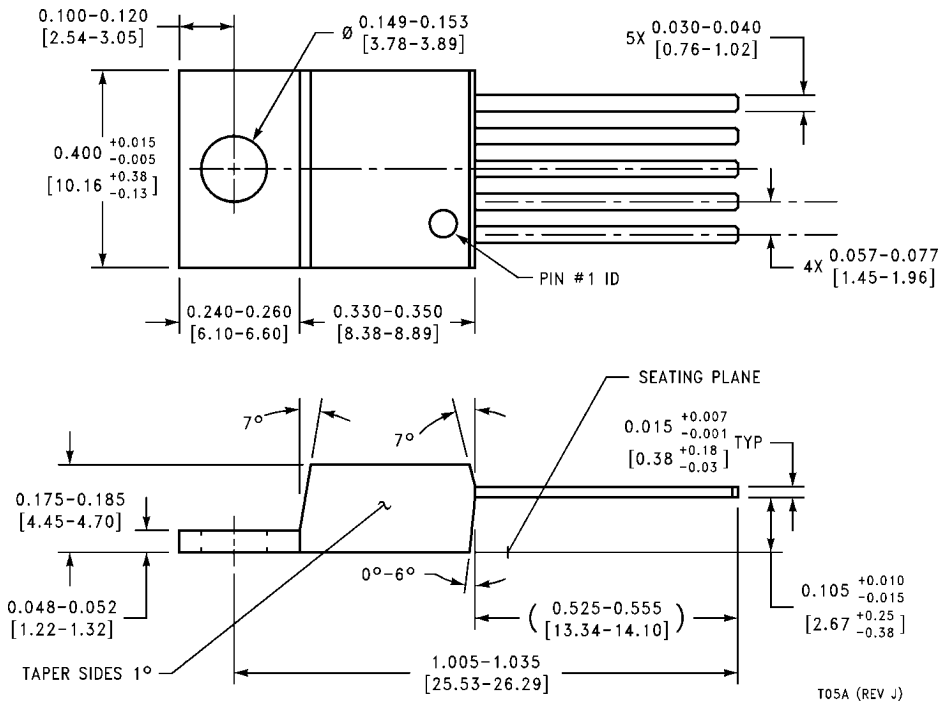

Order Number LM2941T or LM2941CT
 NS Package Number T05A

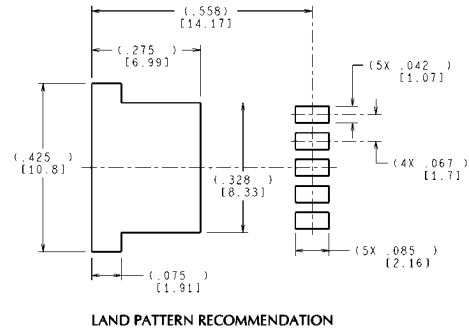
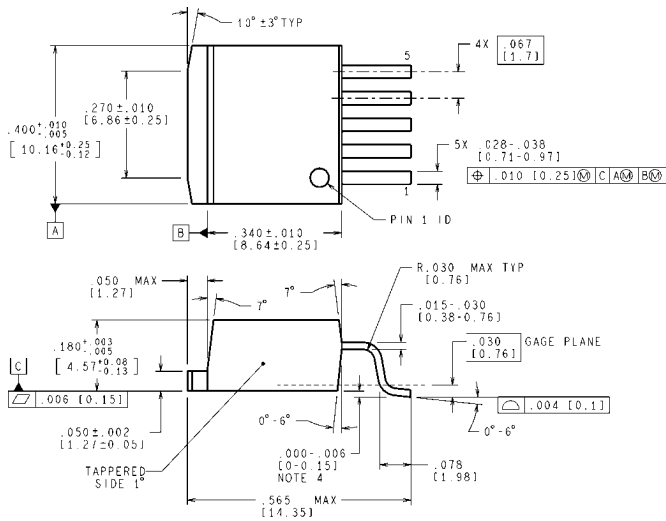

CONTROLLING DIMENSION IS INCH
 VALUES IN [] ARE MILLIMETERS
 DIMENSIONS IN () FOR REFERENCE ONLY

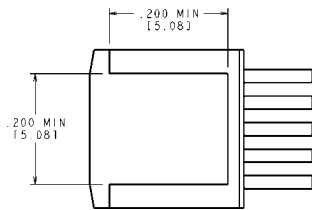

TO-263 5-Lead Plastic Surface Mount Package
 Order Number LM2941S, LM2941SX, LM2941CS or LM2941CSX
 NS Package Number TS5B

TS5B (Rev D)

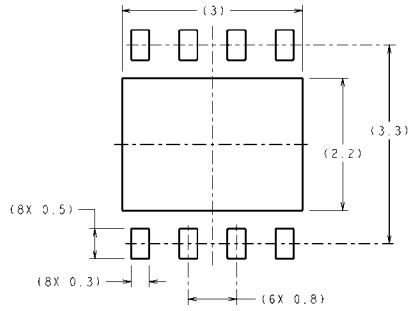

RECOMMENDED LAND PATTERN
1:1 RATION WITH PKG SOLDER PADS

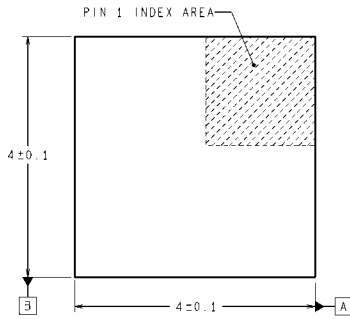

DIMENSIONS ARE IN MILLIMETERS
DIMENSIONS IN () FOR REFERENCE ONLY

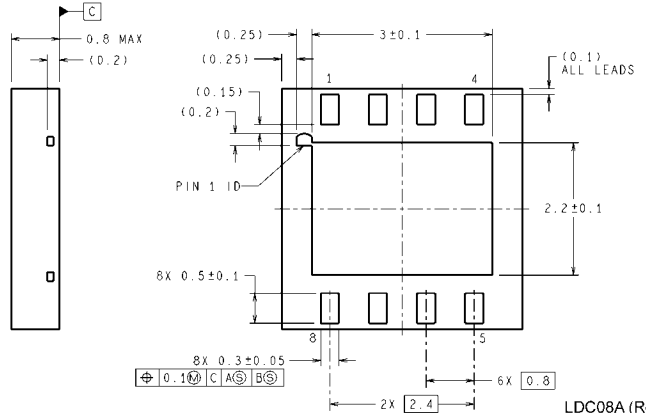

LDC08A (Rev B)

8-Lead LLP Surface Mount Package
Order Number LM2941LD, LM2941LDX
NS Package Number LDC08A

Notes

Notes

For more National Semiconductor product information and proven design tools, visit the following Web sites at:

Products		Design Support	
Amplifiers	www.national.com/amplifiers	WEBENCH	www.national.com/webench
Audio	www.national.com/audio	Analog University	www.national.com/AU
Clock Conditioners	www.national.com/timing	App Notes	www.national.com/appnotes
Data Converters	www.national.com/adc	Distributors	www.national.com/contacts
Displays	www.national.com/displays	Green Compliance	www.national.com/quality/green
Ethernet	www.national.com/ethernet	Packaging	www.national.com/packaging
Interface	www.national.com/interface	Quality and Reliability	www.national.com/quality
LVDS	www.national.com/lvds	Reference Designs	www.national.com/refdesigns
Power Management	www.national.com/power	Feedback	www.national.com/feedback
Switching Regulators	www.national.com/switchers		
LDOs	www.national.com/ldo		
LED Lighting	www.national.com/led		
PowerWise	www.national.com/powerwise		
Serial Digital Interface (SDI)	www.national.com/sdi		
Temperature Sensors	www.national.com/tempsensors		
Wireless (PLL/VCO)	www.national.com/wireless		

THE CONTENTS OF THIS DOCUMENT ARE PROVIDED IN CONNECTION WITH NATIONAL SEMICONDUCTOR CORPORATION ("NATIONAL") PRODUCTS. NATIONAL MAKES NO REPRESENTATIONS OR WARRANTIES WITH RESPECT TO THE ACCURACY OR COMPLETENESS OF THE CONTENTS OF THIS PUBLICATION AND RESERVES THE RIGHT TO MAKE CHANGES TO SPECIFICATIONS AND PRODUCT DESCRIPTIONS AT ANY TIME WITHOUT NOTICE. NO LICENSE, WHETHER EXPRESS, IMPLIED, ARISING BY ESTOPPEL OR OTHERWISE, TO ANY INTELLECTUAL PROPERTY RIGHTS IS GRANTED BY THIS DOCUMENT.

TESTING AND OTHER QUALITY CONTROLS ARE USED TO THE EXTENT NATIONAL DEEMS NECESSARY TO SUPPORT NATIONAL'S PRODUCT WARRANTY. EXCEPT WHERE MANDATED BY GOVERNMENT REQUIREMENTS, TESTING OF ALL PARAMETERS OF EACH PRODUCT IS NOT NECESSARILY PERFORMED. NATIONAL ASSUMES NO LIABILITY FOR APPLICATIONS ASSISTANCE OR BUYER PRODUCT DESIGN. BUYERS ARE RESPONSIBLE FOR THEIR PRODUCTS AND APPLICATIONS USING NATIONAL COMPONENTS. PRIOR TO USING OR DISTRIBUTING ANY PRODUCTS THAT INCLUDE NATIONAL COMPONENTS, BUYERS SHOULD PROVIDE ADEQUATE DESIGN, TESTING AND OPERATING SAFEGUARDS.

EXCEPT AS PROVIDED IN NATIONAL'S TERMS AND CONDITIONS OF SALE FOR SUCH PRODUCTS, NATIONAL ASSUMES NO LIABILITY WHATSOEVER, AND NATIONAL DISCLAIMS ANY EXPRESS OR IMPLIED WARRANTY RELATING TO THE SALE AND/OR USE OF NATIONAL PRODUCTS INCLUDING LIABILITY OR WARRANTIES RELATING TO FITNESS FOR A PARTICULAR PURPOSE, MERCHANTABILITY, OR INFRINGEMENT OF ANY PATENT, COPYRIGHT OR OTHER INTELLECTUAL PROPERTY RIGHT.

LIFE SUPPORT POLICY

NATIONAL'S PRODUCTS ARE NOT AUTHORIZED FOR USE AS CRITICAL COMPONENTS IN LIFE SUPPORT DEVICES OR SYSTEMS WITHOUT THE EXPRESS PRIOR WRITTEN APPROVAL OF THE CHIEF EXECUTIVE OFFICER AND GENERAL COUNSEL OF NATIONAL SEMICONDUCTOR CORPORATION. As used herein:

Life support devices or systems are devices which (a) are intended for surgical implant into the body, or (b) support or sustain life and whose failure to perform when properly used in accordance with instructions for use provided in the labeling can be reasonably expected to result in a significant injury to the user. A critical component is any component in a life support device or system whose failure to perform can be reasonably expected to cause the failure of the life support device or system or to affect its safety or effectiveness.

National Semiconductor and the National Semiconductor logo are registered trademarks of National Semiconductor Corporation. All other brand or product names may be trademarks or registered trademarks of their respective holders.

Copyright© 2007 National Semiconductor Corporation

For the most current product information visit us at www.national.com



**National Semiconductor
Americas Customer
Support Center**
Email:
new.feedback@nsc.com
Tel: 1-800-272-9959

**National Semiconductor Europe
Customer Support Center**
Fax: +49 (0) 180-530-85-86
Email: europe.support@nsc.com
Deutsch Tel: +49 (0) 69 9508 6208
English Tel: +49 (0) 870 24 0 2171
Français Tel: +33 (0) 1 41 91 8790

**National Semiconductor Asia
Pacific Customer Support Center**
Email: ap.support@nsc.com

**National Semiconductor Japan
Customer Support Center**
Fax: 81-3-5639-7507
Email: jpn.feedback@nsc.com
Tel: 81-3-5639-7560